

SPA OWNER'S MANUAL



WELLNESS SHOP

IMPORTANT SAFETY INSTRUCTIONS

READ & FOLLOW ALL INSTRUCTIONS

SAVE THESE INSTRUCTIONS

To view or print this document in French, please visit:

<http://www.wellnessshop.ca>



OM-WELLNESS SPAS - 24G

INDEX

Table of Contents

BRAND CONFIGURATION TABLE.....	3
SAFETY SIGN	4
ATTENTION: SPA OWNER	4
CONDITIONS OF WARRANTY AND CONSUMER OBLIGATIONS.....	5
YOUR PERSONAL SPA DATA.....	6
IMPORTANT SAFETY INSTRUCTIONS	7
READ AND FOLLOW ALL INSTRUCTIONS	8
SAVE THESE INSTRUCTIONS.....	8
INSTALLATION INSTRUCTIONS.....	9
ELECTRICAL CONNECTION GENERAL INFORMATION	11
NORTH AMERICAN (60HZ) MODELS	12
240 VOLT SUPPLY CONNECTION.....	13
START-UP.....	16
K1000 CONTROL PANEL USER GUIDE	18
MAINTENANCE	27
FILTER SYSTEM.....	29
DRAINING YOUR SPA	30
WINTERIZING YOUR SPA.....	32
TROUBLESHOOTING YOUR SPA	33
WATER TREATMENT GUIDE.....	38
PURE WATER SYSTEM.....	42

BRAND CONFIGURATION TABLE

Line	Model	Frame/Bottom	Filter	Keypad User Guide
Wellness Spas	WS103	Polysteel / Sheet	Ultraskim	K1000
	WS104	Polysteel / Sheet	Ultraskim	K1000

CONGRATULATIONS ON THE PURCHASE OF YOUR NEW SPA

We have compiled a complete, easy to understand manual all about your spa and its' maintenance. Years of research and development have gone into producing the superior quality product you have purchased. Your spa is made from the highest quality material and latest technology available today. Pride and meticulous attention to detail have resulted in the spa you have chosen. With proper care, your spa will provide many years of comfort and pleasure.

Please take a few minutes now to read all the instructions before you install your spa. This owner's manual will help you understand your spa, so you will get the most from your investment. For service and advice, do not hesitate to call your authorized dealer. Your questions will be welcomed by friendly and knowledgeable staff.

May you have as much pleasure and enjoyment using your new spa, as we had making it for you.

*We understand there are many choices in the marketplace when you are considering adding a spa to your home, so thank you for choosing a spa by Hydropool Inc. **Enjoy!***

SAFETY SIGN

Important Notice: Safety Sign

Enclosed with this Owner's Manual is a Safety Sign. This sign must be permanently installed in a location that is visible to all spa users. It is the spa owner's responsibility to remind all users about safe spa use, particularly occasional users of the spa, who may not be aware of the various health and safety issues.

To obtain additional or replacement copies of the safety sign, contact your dealer.

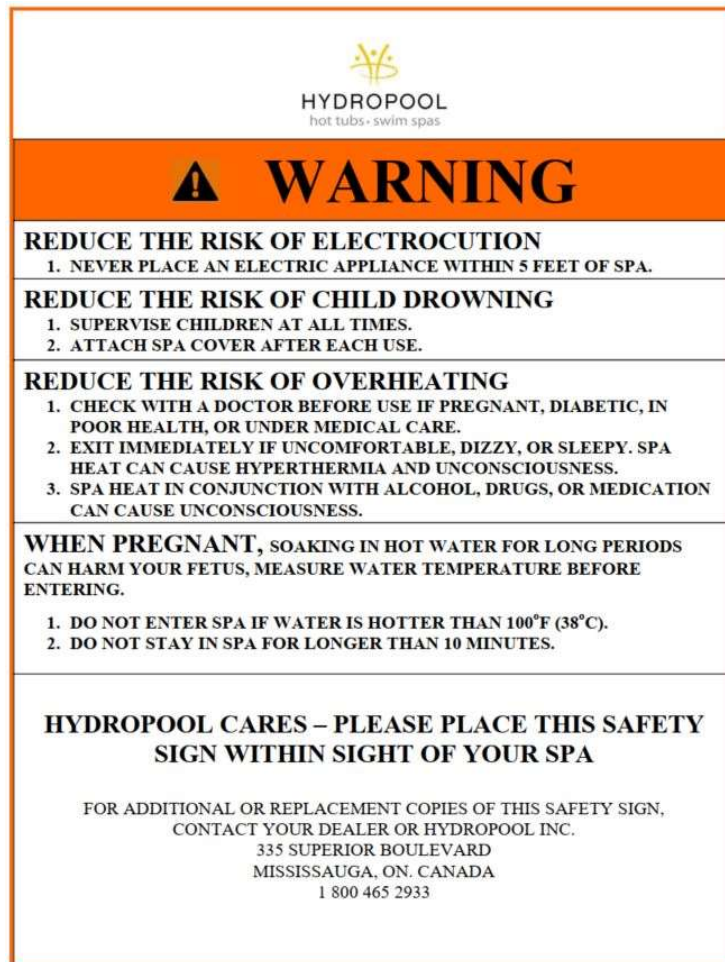

ATTENTION: SPA OWNER

In the immediate vicinity of the spa, a sign must be posted stating the following:

- 1) The address.
- 2) Location of the nearest telephone with posted emergency numbers.
- 3) Nearest available police department, fire department and ambulance/rescue unit.

CONDITIONS OF WARRANTY AND CONSUMER OBLIGATIONS

As a new spa owner, you have specific obligations regarding the installation and safe use of this spa. Failure to do so may result in a loss of warranty coverage not to mention personal injury to those using this spa.

Inspect the spa upon its arrival for damage. If you are being made aware of this for the first time, your spa may not have been delivered in its original factory packaging. If this is the case, please take time to inspect your spa and report any damage or missing items to your dealer.

- 1) Install the spa both physically and electrically, in accordance with any local codes.
- 2) Provide suitable access to all sides of the spa. Any custom-built enclosure, either above or below a deck surface, must be able to be removed with relative ease.
- 3) Provide sufficient work area around the spa's perimeter especially the side the spa's equipment is located on.
- 4) Regularly check operation of the spa regarding filtration, jet pump operation and the heating system.
- 5) Report any concern to the dealer. Any problem that arises towards the end of warranty coverage should be documented and reported to the dealer.
- 6) Maintain the water's chemical balance and clean/replace the system's cartridge filter(s) as instructed by the dealer and/or Leisure Manufacturing Inc.
- 7) Drain and refill the spa on a regular basis as instructed by the dealer and/or Leisure Manufacturing Inc.
- 8) Winterize and store the spa and its' components in accordance with the manufacturer's printed instructions.
- 9) Care for and maintain the spa cabinet, hard cover and acrylic surface as outlined in these instructions.
- 10) Ask your dealer to record the spa's serial number on your bill of sale.
- 11) Provide a copy of your bill of sale, if requested by the dealer or Leisure Manufacturing Inc.

YOUR PERSONAL SPA DATA

Before you begin the installation of your new spa, please take a few minutes to fill out the details of your spa. This information will become invaluable later should you have a question for your dealer or should you need to make a warranty claim. Ask your dealer to assist you in recording this information.

Model Year

Model Name/Number

Spa Serial#

Jet Pump(s) Size (HP, SPL, Watts etc.)

Heater size (kw)

Filter Cartridge (Model Number/Size)

Topside Control/Keypad

Spa Pack Model #

Spa Pack Serial #

Dealer Name

Date of Purchase

We strongly recommend that you attach your bill of sale to this manual after installation is complete. Keep it in a safe place for future reference. You may also wish to attach any notes you have made about the dealer delivery; dealer start up demo or any other notes that may be of benefit in the future.

IMPORTANT SAFETY INSTRUCTIONS

Warnings

DANGER: Risk of Accidental Drowning. Extreme caution must be exercised to prevent unauthorized access by children. To avoid accidents, ensure that children cannot use this spa unless they are supervised at all times.

DANGER: Risk of Injury. The suction fittings in this spa are sized to match the specific water flow created by the pump. Should the need arise to replace the suction fittings or the pump, be sure that the flow rates are compatible.

Never operate spa if the suction fittings are broken or missing. Never replace a suction fitting with one rated less than the flow rate marked on the original suction fitting.

DANGER: Risk of Electric Shock. Install at least 5 feet (1.5m) from all metal surfaces. As an alternative, a spa may be installed within 5 feet of metal surfaces if each metal surface is permanently connected by a minimum 8 AWG (8.4mm²) solid copper conductor to the wire connector on the terminal box that is provided for this purpose.

DANGER: Risk of Electric Shock. Do not permit any electrical appliance, such as a light, telephone, radio, or television, within 5 feet (1.5m) of a spa.

WARNING: To reduce the risk of injury:

- a) The water in a spa should never exceed 40°C (104°F). Water temperatures between 38°C (100°F) and 40°C are considered safe for a healthy adult. Lower water temperatures are recommended for young children and when spa use exceeds 10 minutes.
- b) Since excessive water temperatures have a high potential for causing fetal damage during the early months of pregnancy, pregnant or possibly pregnant women should limit spa water temperatures to 38°C (100°F).
- c) Before entering a spa, the user should measure the water temperature since the tolerance of water temperature-regulating devices varies.
- d) The use of alcohol, drugs, or medication before or during spa use may lead to unconsciousness with the possibility of drowning.
- e) Obese persons and persons with a history of heart disease, low or high blood pressure, circulatory system problems or diabetes should consult a physician before using a spa.
- f) Persons using medication should consult a physician before using a spa since some medication may induce drowsiness while other medication may affect heart rate, blood pressure, and circulation.



CAUTION:

Maintain water chemistry in accordance with the manufacturer's instructions.

READ AND FOLLOW ALL INSTRUCTIONS

When using this equipment, basic safety precautions should always be followed. Including the following:

- a) A green coloured terminal or a terminal marked G, GR, Ground, Grounding, or the international grounding symbol is located inside the supply terminal box or compartment. To reduce the risk of electric shock, this terminal must be connected to the grounding means provided in the electric supply service panel with a continuous copper wire equivalent in size to the circuit conductors supplying this equipment.
- b) At least two lugs marked "BONDING LUGS" are provided on the external surface or on the inside of the supply terminal box or compartment. To reduce the risk of electric shock, connect the local common bonding grid in area of the hot tub or spa to these terminals with an insulated or bare copper conductor not smaller than No.6 AWG.
- c) All field-installed metal components such as rails, ladders, drains or other similar hardware within 3m (10ft) of the spa or hot tub shall be bonded to the equipment grounding bus with copper conductors not smaller than No.6 AWG.

DO NOT connect your spa to an extension cord.

SAVE THESE INSTRUCTIONS

Important Safety Instructions

Hyperthermia

Prolonged immersion in hot water may induce hyperthermia. Hyperthermia occurs when the internal temperature of the body reaches a level several degrees above the normal body temperature of 37°C (98°F). The symptoms of hyperthermia include drowsiness, lethargy, and an increase in the internal temperature of the body. The effects of hyperthermia include:

- Unawareness of impending hazard.
- Failure to perceive heat.
- Failure to recognize the need to exit spa.
- Physical inability to exit spa.
- Fetal damage in pregnant women.
- Unconsciousness and danger of drowning.



WARNING:

The use of alcohol, drugs or medication can significantly increase the risk of fetal hyperthermia.

INSTALLATION INSTRUCTIONS

Remember, your new spa is a powerful piece of electrical and plumbing equipment. You owe it to yourself, your family, and your friends to install it correctly and safely. Before attempting to hook-up or use your spa, please read the following instructions.



ATTENTION:

This spa is intended for outdoor use; however, it can be installed indoors when precautions are taken to ensure the spa is installed and located in such a manner that any water that could leak, splash or be released as humidity will drain away harmlessly.

Positioning Of Your Spa - Considerations

Your spa is completely self-contained. Therefore, you can situate it just about anywhere, on a patio, in or on a deck, in a basement or sunroom. It comes completely pre-plumbed, and water tested from the factory. Never lift or carry the spa by the plumbing. Damage could occur which would not be covered under warranty.

You should consider the following when selecting prospective spa sites to maximize enjoyment.

To avoid any personal injury or damage to your spa, have 4-5 people ready to assist you to move the spa to its' final location. Use a moving dolly and/or straps to distribute the spa's weight more evenly. Never lift or carry the spa by its' plumbing.

Site Considerations

Local codes	Local building, property and electrical codes may affect your installation.
Delivery access to location	Gates, overhangs, fences, gas meters, and AC units may become obstructions. You may need to access from a neighbour's yard or employ a crane.
Vegetation in spa area	Trees, bushes, flowers etc. can all add to spa maintenance.
Spa location relative to buildings	The location could add to your spa maintenance (removing snow from cover) and increase operating costs.
Fences, tree lines	More privacy during use and serves as a wind break but may also add more maintenance.
Spa step out location	Any surface that is slippery when wet could be dangerous for bathers both entering and exiting the spa.
Spa Direction	View when using a lounger & ease of access for servicing.
Downspouts and natural drainage of land	These may flood the spa area, damage spa or create a safety hazard to bathers.
Outside water supply and draining location	You will need a place to safely drain the spa and a way to refill it easily.
Optional accessories	These may take up added space that you must plan for (cover remover/holder).

Spa Support

Whatever the support is, it must be:

- a) A continuous, level surface, above grade, capable of handling 80 lbs. per sq. ft. that will not be compromised by changes in the water table or water sitting in the area.
- b) Such that the weight of the spa, water and bathers is not supported by the spa lip.
- c) In full contact with the bottom of the spa

Acceptable Spa Support Bases

Concrete Pad	4" to 6" thick with provision for run off
Patio Stones, Pavers etc.	Levelled with proper preparation of the earth
Wooden Deck Floor	Incl. centre support uprights in concrete and joists spaced 12" on centre

Unacceptable Spa support bases include crushed gravel, stone dust, bare earth, platform built directly onto earth. **Damage caused by improper spa installation will void factory warranty.**

Do NOT locate your spa in a low run-off area since melting snow or rain can cause pump and equipment damage. WATER SHOULD ALWAYS DRAIN AWAY FROM THE SPA.

See next page for dimensions that can be used to determine the proper location of submerged conduits in concrete slab installations. All dimensions are made from the outside of the spa's frame with the access panels removed.



ELECTRICAL CONNECTION GENERAL INFORMATION

A. Supply Cable Entry into Spa Equipment Area

- You may enter the spa cavity at any other point around spa provided you have reviewed the location and determined there is no interference. You may also decide to enter at an adjoining wall (depending on the positioning of the spa) and route a conduit along the spa kicker. Ask your electrician for his/her advice in these matters.
- In all cases the best side for entry of the supply cable is the side to your left when you are standing at the equipment panel.
- Right side entry is possible; however, this may involve additional supply cable, parts, and time.

How To Pass the Cable Through The Spa Enclosure

Polysteel Frame with Polyethylene Bottom and Polysteel Panels

- a) You can choose to notch the Polysteel panel so you can pass the cable/conduit through and still be able to remove/replace the panel for servicing. You should consider securing the cable or conduit to the spa's metal frame where cable/conduit passes through the cabinet.
- b) You may also route a cable up under the corner. The curved panel is flexible enough and there is enough space to run the cable this way. Removing the corner may help you to do this easier.
- c) On a concrete pad where you have a conduit or cable coming up within the perimeter of the spa, you can easily cut an opening in the polyethylene bottom to access the cable or conduit/wires. See above table for recommended opening location.

You may wish to insulate any opening or cut-out you make in the spa's cabinet panel or corner or bottom to keep cold air and small animals out.

NORTH AMERICAN (60HZ) MODELS

Please note the following important information:

When using this electrical equipment, basic safety instructions should be followed, including the following:

Read and Follow ALL Directions

- 1) Electrical installation must be carried out by a qualified electrician strictly in accordance with local governing codes.
- 2) A terminal marked "ground" is located within the control box. To reduce the risk of electric shock this terminal must be connected to the grounding means provided in the electric supply service panel with a continuous copper wire equivalent in size to the circuit conductors supplying the equipment.
- 3) At least two lugs marked "bonding lugs" are provided on the external surface of the control box. To reduce the risk of electric shock, connect the local common bonding grid in the area of the hot tub or spa to these terminals with an insulated or bare copper conductor not smaller than No. 6 AWG.
- 4) All field installed metal components such as rails, ladders, drains or other similar hardware within 3m (10 ft.) of the spa or hot tub shall be bonded to the equipment grounding bus with copper conductors not smaller than No. 6 AWG.
- 5) Test the ground fault circuit interrupter before each use of the spa.
- 6) Before servicing any electrical components of the system make sure that the power supply is switched off.

240 VOLT SUPPLY CONNECTION

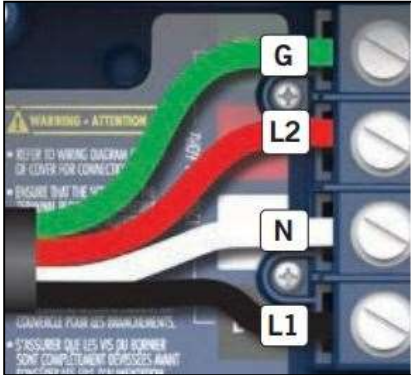

IN.YE SPA PACK

Power Requirements

240VAC, 60Hz, Class A GFCI-protected service

4 wires (Hot-Line 1, Hot-Line 2, Neutral, Ground)

For current requirements & breaker rating see nameplate on spa.

Power Up Screen

Each time the system powers up, a series of numbers is displayed. After the start-up sequence of numbers, the system will enter Priming Mode. Next, refer to the User Guide for your keypad at the back of this manual.



CAUTION:

Electrical installation must be carried out by a qualified electrician, strictly in accordance with local governing codes.
Use only Class A Ground Fault Circuit Interrupter.

Typical North American GFCI

Several different models of GFCIs are available on the market. Note that our illustrations are generic.

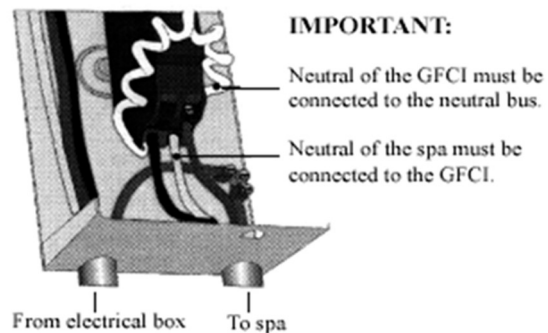

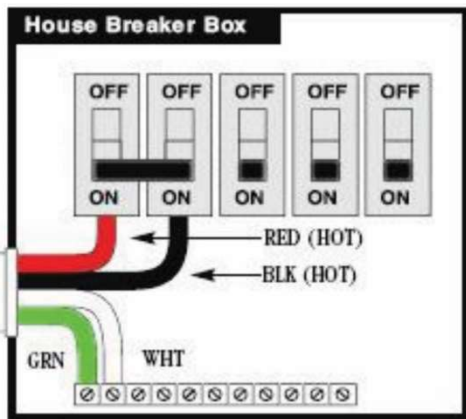

Important: Installation of this GFCI Circuit Breaker, including Ampere sizing and selection of conductor size and type, must be performed by a qualified electrician in accordance with the National Electrical Code, or the Canadian Electrical Code, and all federal, state, and local codes and regulations in effect at the time of installation.

Note: The white Neutral wire from the back of the GFCI must be connected to the incoming Line Neutral. The internal mechanism of the GFCI requires this neutral connection. The GFCI will not work without it.

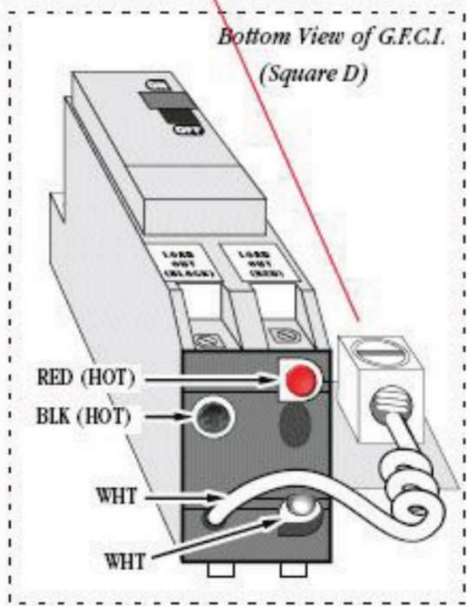
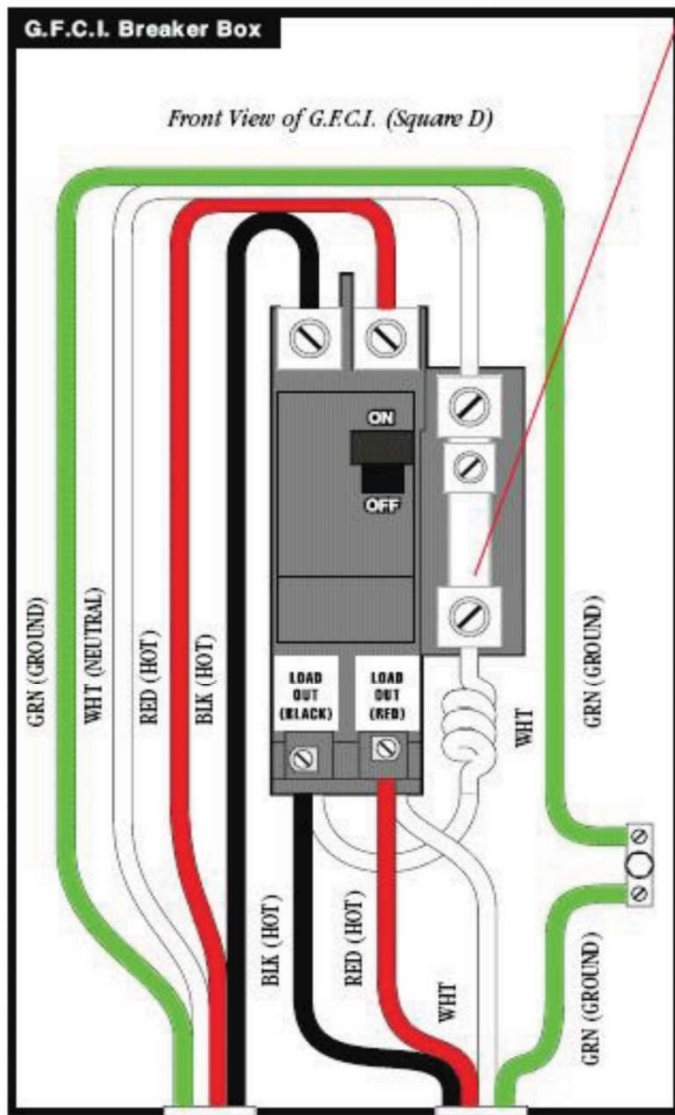

To connect spa pack, refer to electrical diagram located on next page

Wire Size and Over Current Protection (Canada/US)

Amp rating of spa		Supply Wire type and size		Over Current Protection (amps)
More than	To	60C copper, AWG	75C copper, AWG	
16	20	10	10	25
20	24	10	10	30
24	28	8	10	35
28	32	8	8	40
32	36	6	8	45
36	40	6	8	50
40	48	4	6	60

Note: If your GFCI trips immediately on start-up or during the opening use of the spa, **DO NOT USE THE SPA** and take precautions to ensure that no one uses the spa, while you contact your dealer/electrician. GFCI trips on newly installed spas are predominantly caused by mis-wired GFCIs.

SPECIAL NOTE: DISCONNECT SWITCH

This unit must be connected to a disconnect that de-energizes power to the entire unit for servicing, maintenance or the like. The disconnect switch, with marked "OFF" position, must be located within sight from the equipment and at least 5ft. (1.52m) from the inside walls of the spa.

SPECIAL NOTE: EMERGENCY SWITCH

This unit is intended for use in a single-family dwelling. When used in locations other than a single-family dwelling, a clearly labelled emergency switch, readily accessible to the occupants and at least 5ft. (1.52m) away from the unit, shall be provided as part of the installation.

START-UP

How Your Spa Works

Circulating, Heating and Filtering

Low speed of a 2-speed pump. Immersion titanium heating element in every hot tub.

Filter System

Single cartridge system that is accessible from inside the spa.

Hydrotherapy

A 2-speed jet pump provides a gentle, low-speed therapy or intense, high-speed therapy. The jets have directional nozzles, multiple directional nozzles, fixed nozzles, or rotating nozzles. Most of the jets can have the water volume adjusted to your therapy needs.

Deck Controls

Air controls mix air with the water stream coming out of the jet. Models with the waterfall feature have a control valve to turn the waterfall on/off.

A digital topside control panel allows you to activate the pumps, blower and light plus set the temperature that you want the water to be. The topside display also shows error messages and tells you if any special spa pack features are operating, including protection against overheating and freeze-up.

LED Light Operation

Your spa may be equipped with an LED light system consisting of perimeter lights, lighted water feature(s), and a thru wall underwater spa light, depending on the spa model and options. The system is controlled using the LIGHT key on the topside control panel. The spa pack is factory set/programmed for simple on/off spa light operation. Note that not all colours are available on all LED systems.

Operation: To move from setting to setting simply turn the LIGHT key on/off.

If the light is turned OFF for more than 5 seconds, the sequence automatically restarts at the last colour shown.

Light Sequence

- 1ST Press – Rotating Colours
- 2nd Press – Solid Blue Colour
- 3rd Press – Solid Green Colour
- 4th Press – Solid Red Colour

Note: Pressing the light key in intervals less than five seconds will scroll to the next colour. Once you have selected the colour another press will turn the light off.

LIGHT AUTOMATIC TIME-OUT

Time Out – 60 minutes

Filling Your Spa

Okay, your new spa has been connected to the power and you have a basic understanding of how the equipment works and what the jets can do for you. We know you are anxious to fill the spa and get it started, but please read this section carefully before you fill your spa.

- 1) Make certain that the breaker or fuse(s) that supplies your spa equipment is off.
- 2) Wash the spa surface thoroughly with warm water and a soft cloth only to remove any construction or transportation debris.
- 3) Check that the drain connection is closed.
- 4) Check that the unions on the spa pack and pump(s) are tight. They can loosen during transportation.
- 5) Remove the filter cartridges. Open waterfall/water feature ON/OFF valve before filling. Refer to graphics on valve handle or simply turn counterclockwise to open.
- 6) Begin filling the spa with a standard garden hose. Fill by inserting hose into filter body, in the case of a lily pad style filter, or by positioning hose into a cartridge mount located in the filter well. Do not fill your spa with soft water (consult dealer). If possible, your source fill water temperature should not be less than 70°F (21°C). Do Not operate the spa with low water levels. Initial water level should be 6" below the spa lip. Adjust as needed based on number of bathers using the spa. Consider adding an overflow to your spa if you are regularly having enough bathers in the spa to significantly raise the water level such that damage to equipment may occur.
- 7) Increase the fill pressure slowly to prevent surface damage by a jerking hose.
- 8) Visually check all lines for leaks and correct immediately. If you cannot stop the leak simply by tightening a union or resetting an "O" ring or gasket, contact your dealer immediately.
- 9) Turn on the main power at your electrical panel.
- 10) The topside control panel will initialize and begin its' start-up procedure. Then the system will start the circulation pump (or low speed pump) and the heater.
- 11) Re-install the filter cartridges.

IMPORTANT:

Now, read about the keypad operation, user settings, system defaults, automatic functions and display messages included in this manual (see User Guide in the Index).
Take a few minutes to try the various keys and features on your new spa.

Once you feel comfortable with the operation of your spa's controls, set the temperature to the desired level (100°F/38°C is an excellent starting point). Close the air controls and cover the spa with your hard cover. Heat up times will vary based on volume of water in the spa, but you can generally expect 6-8 hours to reach maximum temperature. Spas running on 120VAC will have a longer initial heat-up time.

Always view the temperature display before entering the water. For your own personal safety, do not enter when the temperature exceeds the maximum set point of 40°C (104°F).

K1000 CONTROL PANEL USER GUIDE

INITIAL START-UP

Before applying voltage to power-up your hot tub, it is very important that you understand the sequence of events that occur when the system is activated in order that the pump(s) can be primed efficiently and damage to the system can be avoided.

At initial power-up, the system will show the following screen.

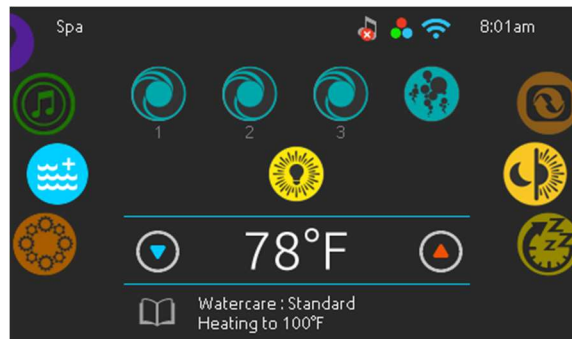

The keypad does store the date and time for a limited time so when the system starts up after a loss of power it may be necessary to reprogram the time and date if the power down duration is greater than 48 hours.

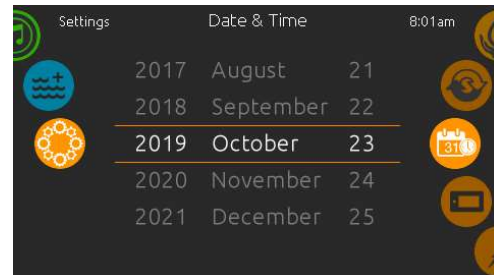
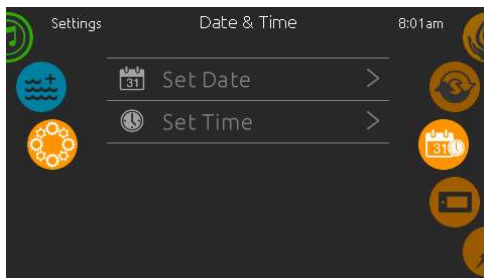

PROGRAMMING THE DATE AND TIME

Here you can adjust the time format (AM/PM or 24h), day of the week and time. Use the icons to choose the setting that you want to adjust and select it by scrolling through the menu.

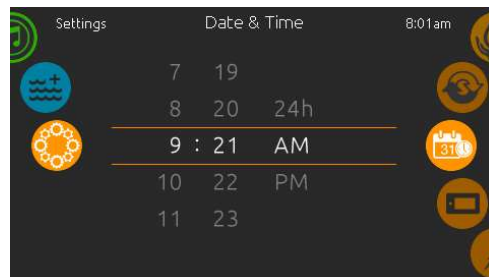



TEMPERATURE CONTROL FUNCTIONALITY AND ADJUSTMENT

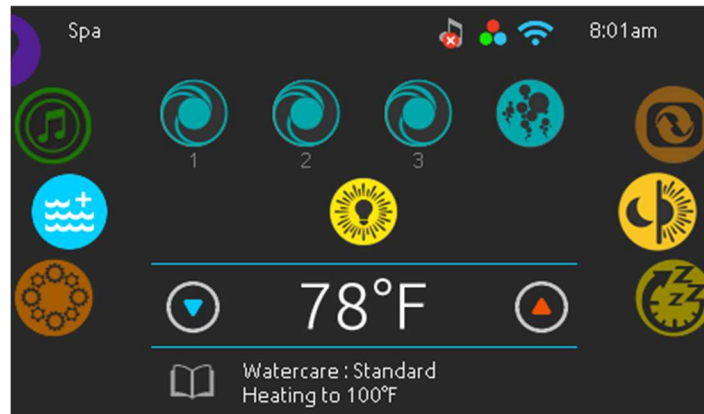

After you exit the programming mode your hot tub will automatically heat to the factory preset default temperature of 38°C (100°F).

The temperature shown in white on the screen is the current water temperature. Use the UP and DOWN icon to set the desired temperature.

The set point will appear in blue on the screen. After 3 seconds without any change to the set temperature value, the keypad will resume the normal display of messages.

When the set value is lower than the current temperature "Cooling to XX"°F ("C)" will appear.

When the value is set higher than the current temperature, "Heating to XX"°F ("C)" will be indicated.

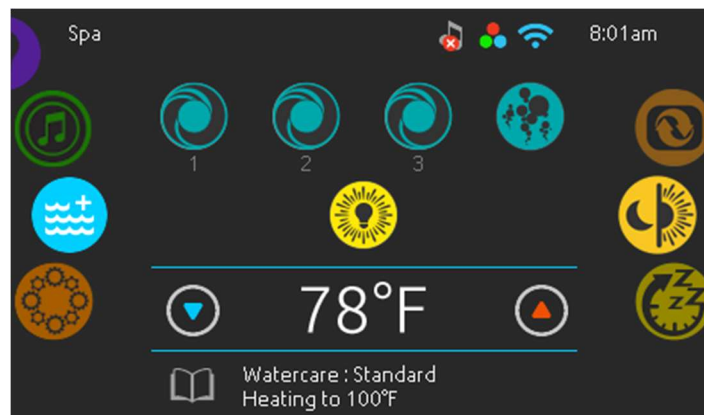

WELLNESS SHOP SERIES CONTROL SYSTEMS



KEYPAD FUNCTIONS AND DISPLAY ICONS



**SPA
FUNCTION
KEY**



**SETTINGS
FUNCTION
KEY**



**QUICK
START / STOP
KEY**



**PUMP 1
FUNCTION
KEY**



**PUMP 2
FUNCTION
KEY**



**LIGHT
FUNCTION
KEY**



**TEMP
UP
KEY**



**TEMP
DOWN
KEY**

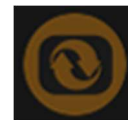

**INVERT
DISPLAY
KEY**



**DAY
NIGHT
CONTRAST**



**SLEEP
MODE
KEY**

PUMP 1 FUNCTION

Press this pad to activate the pump.

- 1st press – low speed (**icon rotates slow**)
- 2nd press – high speed (**icon rotates fast**)
- 3rd press – turns the pump off.



PUMP AUTOMATIC TIME-OUT

Low and High speed – 15 minutes

PUMP 2 FUNCTION

Press this pad to activate the pump.

- 1st press – high speed (**icon rotates fast**)
- 2nd press – turns the pump off.



PUMP AUTOMATIC TIME-OUT

Low and High speed – 15 minutes

SETTINGS KEY

From the home page you can access the **SETTINGS**, where you will find:

- Water Care
- Maintenance
- Day & Time
- Keypad Settings
- Miscellaneous
- Electrical Configuration
- About



Use the icon keys to scroll up and down in the list. To select an option, press the text.

At any point you can press the Spa Function icon to return to the home screen.

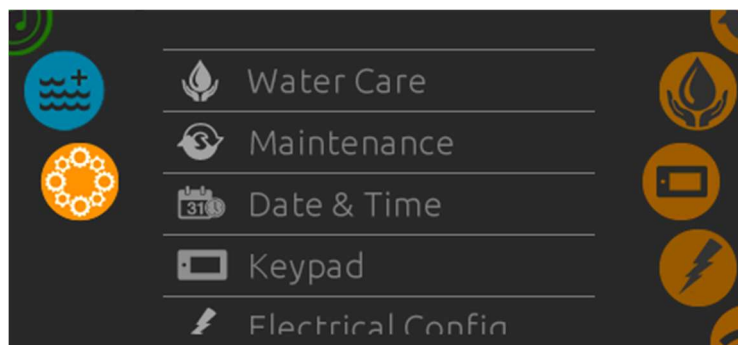

WATER CARE

The Water Care section will help you set up your ideal filtration and heating settings. Choose from Away, Beginner, Energy Savings, Super Energy Savings and Weekender, depending on your needs. Use the Light key to choose your setting. A checkmark will appear on the selected icon to confirm. In Energy Savings mode, the set point will be reduced by 20°F (11°C), which means that the heating system will not be engaged unless the temperature falls to 20°F (11°C) below the spa's set temperature.

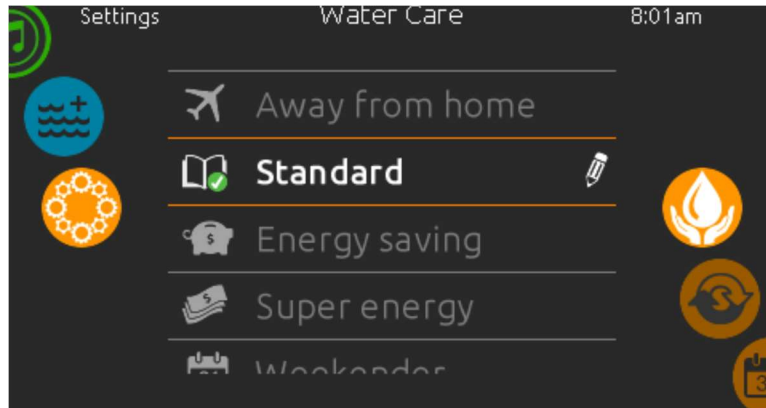

Water Care Modes:

Away:

In this mode the spa will always be in economy; the set point will be reduced by 20°F (11°C), and the filtration can be reduced.

Beginner:

The spa will never be in economy mode and will run a normal 24 hours of filtration a day.

Energy Savings:

The spa will be in economy mode during the peak hours of the day and resume normal mode on the weekend.

Super Energy Savings:

The spa will always be in economy mode during peak hours, every day of the week.

Weekender:

The spa will be in economy mode from Monday to Friday and will run normally on the weekend.

MODIFYING SCHEDULES



To see and/or modify the Water Care category, use the Settings icon to open the selected Water Care menu.

Scroll through the menu to choose a schedule to modify (choice of economy and filtration schedules).

You have several possibilities for the schedule (Mon-Fri, weekend, every day, or single days). The schedules will be repeated every week. The time and duration are set in 30-minute increments. Once you have set the schedule, use Spa Function Icon to go back. Ensure that you have selected the desired Water Care Option in the main Water Care menu.

The filtration schedule shown on the screen will apply to the main filtration pump. Your spa uses a circulation pump configured to run 24 hours by default and the screen will show you the purge setting instead of filtration. The purges are pre-programmed for a fixed number of minutes; therefore, the duration will be set to N/A on the screen, and only the start time can be modified.

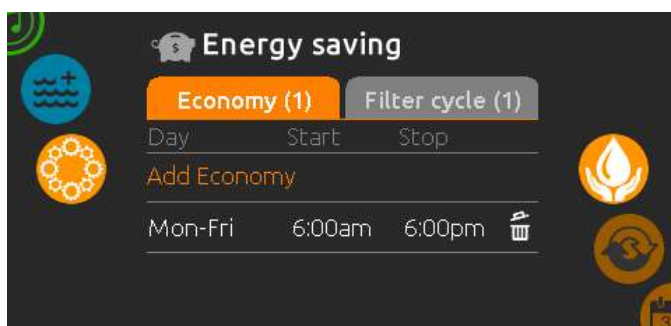
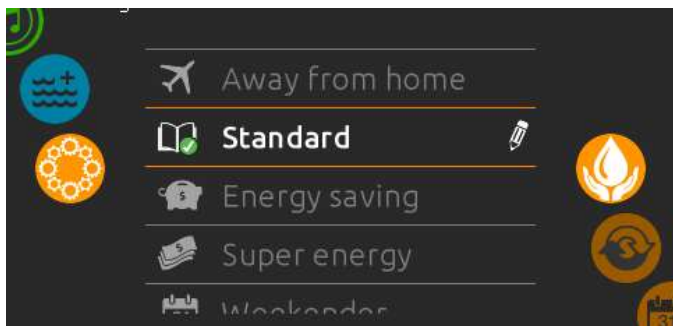

FILTERING

Your spa is equipped with a circulation pump that filters your water for 24 hours a day. If the water temperature exceeds the set temperature by 4°F (and set point is 95°F or higher) then this pump will shut off automatically until the temperature drops below the set point by approximately 1.5°F.

You can bypass the pack filtration over-temperature feature. When Warm weather is "Off", the filtration over-temperature is disabled. This feature allows the spa to continue filtering even through the water temperature is high.

MAINTENANCE

From the Settings page you can access the Maintenance Menu, which gives you access to the following options:

- Maintenance reminders
- Standby

Press the text to select.

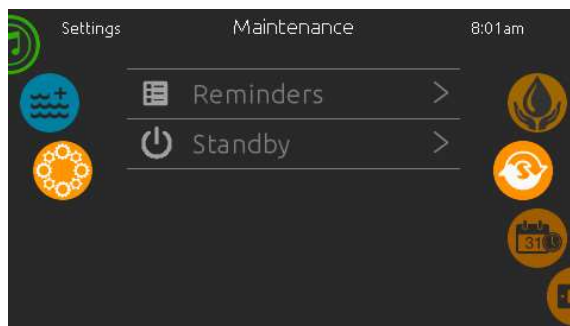

MAINTENANCE REMINDERS

The K1000 keypad will remind you of maintenance required on your spa, like rinsing or cleaning the filter. Each task has its own duration, based on normal use.

The Maintenance Reminders menu allows you to verify the time left before maintenance is required, as well as to reset the time once a task is completed.

Scroll through the menu to move through the list.

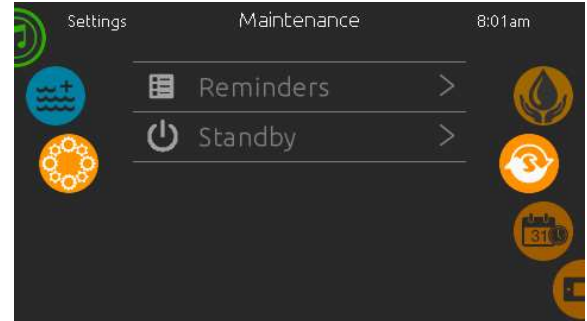

STANDBY

The Standby Mode allows you to service your spa. Pumps will stop for 30 minutes, and automatically restart after this time.

Once Standby mode has been activated a screen will appear to show the pumps are stopped. The normal spa page will return at the end of the maintenance.

Press Cancel to leave Standby mode and restart the spa.

NOTE: If the heater is activated it could take up to 20 minutes for the Standby Mode to be activated as it needs to finish its heat cycle. To avoid this, you will need to drop the set temperature below the water temperature for the Standby Mode to be activated immediately.

DATE AND TIME

Here you can adjust the time format (AM/PM or 24h), day of the week and time. Use the icons to choose the setting that you want to adjust and select it by scrolling through the menu.

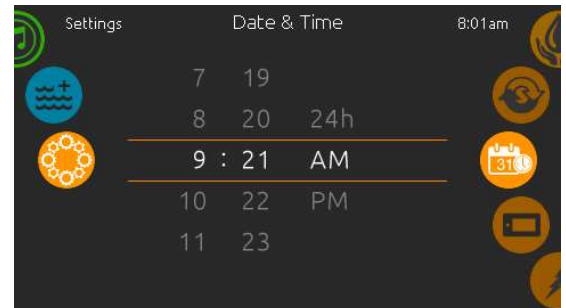
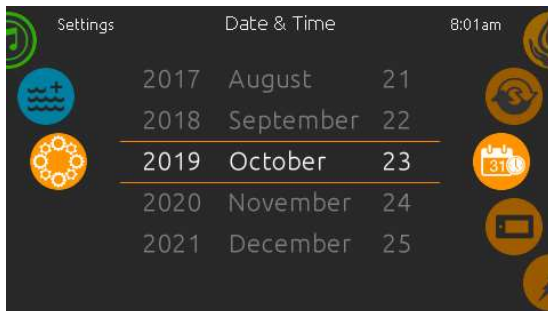

KEYPAD SETTINGS

In this section you can change the temperature unit and language. Use the arrow keys and move to the setting that you would like to change. Use the Light key to choose and the arrow keys to modify.

For the temperature setting you have a choice between Fahrenheit or Celsius.

For the language setting you have a choice between English and French.

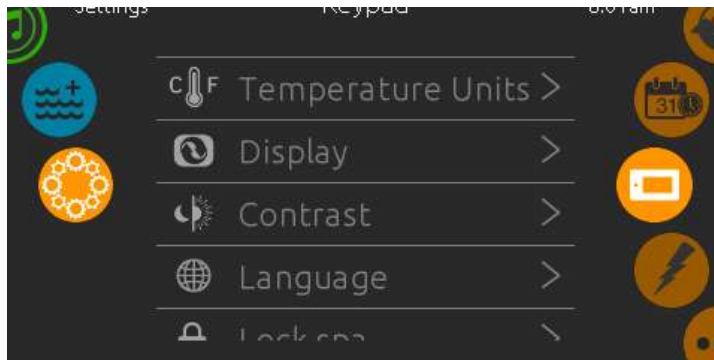

ELECTRICAL CONFIGURATION

Please do not make changes in this section unless you are a qualified electrician.

ABOUT

This section shows information about the keypad software number and the revision numbers of the different components of your system.

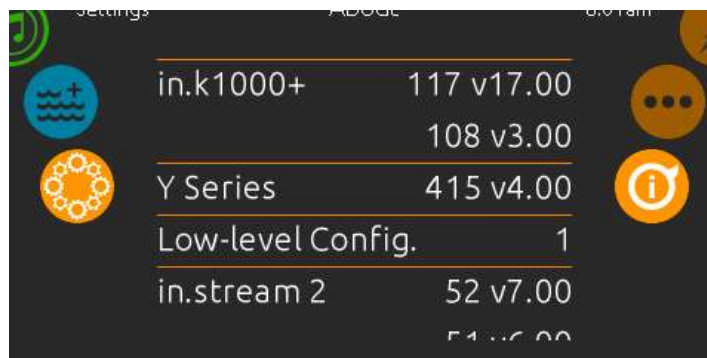

PURGE CYCLES

The purge cycles are programmed to begin at the start of each filter cycle. Pump 2 activates for 1 minute, shuts off and then Pump 1 activates for 1 minute then shuts off.

SMART WINTER MODE

Smart Winter Mode protects your system from the cold by turning the pumps on several times a day to prevent water from freezing in the pipes. The Smart Winter Mode indicator turns on when in this mode of operation. If the temperature drops to 4°C (39°F) within the heater chamber, the system automatically activates the pump to provide freeze protection. The pump will operate until the temperature reaches 5°C (41°F) before returning to normal system mode.

COOLING DOWN

After heating the spa water to the desired set point, the heater is turned off, but the filtration pump remains on for a certain amount of time to ensure adequate cooling of the heating element to prolong the useful life of the heater. "Cooling to XX°F (°C)" message will appear at the bottom of the screen.

ACCESSING FILTER CARTRIDGES

Our various spa models use different filter systems depending on the spa design. Identify which filter system is in your spa and check (√) it off for future reference.

Ultraskim 75 with Locking Ring and Telescoping Weir

Single cartridge, vertically mounted, 75 sq. ft. 14 13/16" (37.6cm) high (part #PLBS75)



1. Shut off your spa at the Ground Fault Circuit Interrupter (GFCI)
2. Remove telescoping weir that is held in place by the locking ring.
3. Remove the debris basket by grasping the inner tab. Dump any debris and set aside.
4. Pull cartridge straight up and out of the filter body.
5. Examine, clean, rotate or replace the cartridge as necessary.
6. Reverse the procedure to install new or cleaned cartridge.

MAINTENANCE

To protect the equipment and the bathers using your spa, regular maintenance must be performed.

Caring For the Acrylic Surface

This beautiful acrylic surface is among the glossiest, high quality surface materials available. It's hard, non-porous surface prevents dirt from accumulating and resists stains better than other plastic materials. With normal use, it is so durable it will retain its beauty with only a minimum of care. So, to maintain the high gloss and elegant look, just follow these simple steps:

- Use common household, non-abrasive cleaners for most cleaning jobs. (For example: LYSOL® BASIN, TUB & TILE CLEANER, GLASS PLUS®, MR.CLEAN® and TOP JOB®, or a mild dishwashing detergent such as IVORY LIQUID®) Rinse well and dry with a clean cloth.
- Never use abrasive cleaners.
- Do not allow your acrylic surface to encounter products such as acetone (nail polish remover), nail polish, dry cleaning solution, lacquer thinners, gasoline, pine oil, etc.
- Remove dust and dry dirt with a soft, damp cloth.
- Clean grease, oil, paint and ink stains with isopropyl (rubbing) alcohol.
- Avoid using razor blades or other sharp instruments that might scratch the surface. Small scratches can be removed by applying a thin coat of automotive paste wax and buffing lightly with a clean cloth. For deeper scratches, sand the surface lightly with 600 grit "wet" sandpaper (never dry) and buff with fine-grit buffing compound.

If you don't rinse off any surface cleaner thoroughly, you will experience excessive foaming on refilling and start-up. Periodic application of a good wax adds lustre to the appearance and protects the finish.

Cleaning The Spa's Cabinet

Cleaning the cabinet is easy and fast with many common household cleaners. The cleaning solution should be applied and immediately wiped dry. The cleaning solution should not be left to stand on the material for an extended period of time.

Recommended Cleaners:

Windex®, Glass Plus®, 409® Glass & Surface Cleaner, Spic and Span Cinch®, Fantastik® All-Purpose, Regency® (Glass & Surface), Clorox® Clean-Up and Fantastik® Orange Action

Cleaners to Avoid:

Harsh cleaners with glycol ethers or ethanol type solvents and/or isopropyl alcohol soften the coating if left on for several minutes.

Cleaners such as Goof Off®, Great Value® All Purpose Cleaner (Wal-Mart), 409® General Purpose, Greased Lightning®, citrus cleaners, abrasive cleaners and solvents such as acetone, paint remover and lacquer thinner are **NOT** recommended for cleaning the cabinet.

Spa Hard Cover

In an uncovered spa, over 90% of the heat loss is from the spa surface. The evaporation also affects the chemical balance and could create humidity problems indoors.

Hard covers are engineered for maximum thermal efficiency and appearance. They are hinged in the middle for easier handling, and the zippers allow the tapered Styrofoam inserts to be changed if damaged.

The skirt on the cover hugs the lip of the spa for a tight fit. The handles are placed so even a large cover can be easily opened by 1 person.

The locks, with one part fastened to the deck or skirt, prevent small children or animals from entering the spa.

- Do not drag the cover across the spa or decking. Fold cover first, and then remove with assistance.
- Do not place the spa where snow loads are excessive on the cover. If snow accumulates on the cover, carefully remove the snow.
- Do not shovel the snow as the cover will tear.
- Do not stand on the hard cover. The cover is not warranted against the foam breaking or the vinyl cover tearing.
- Do not use abrasive cleaners or leather restoration-type cleaners. Use only water and a mild detergent.

Jet Maintenance

Several of the jets in your spa are volume adjustable. The volume adjustment of the jet internals in these jets can be affected by debris in the spa water. If you feel the volume adjustment getting stiff, you should consider removing and washing the internal at the next scheduled fill and drain of the spa.

To Remove an Adjustable Jet Internal

- 1) Turn the jet face to the maximum volume position (fully counterclockwise).
- 2) The jet face will feel as if it has stopped but if you continue to turn the face, the jet internal will thread out of the body.
- 3) Check the inside of the jet body and the internal for any debris and calcium build up.
- 4) Wipe out the inside of the jet body, if necessary.
- 5) Wash the internal in your service sink. Scrub, gently, if necessary.
- 6) To re-install a jet internal simply thread the internal in until it stops. Now continue turning until the internal locks into its volume adjustment range.

If you find high levels of calcium build up or any discoloration of the jet internal when removed, you should take a spa water sample to your dealer for testing.

FILTER SYSTEM

General Information

You will need to regularly inspect your filter cartridges to ensure they are clean.

As your cartridges get dirtier, they could affect:

- **Heating of the spa water:** restricted water flow from a clogged filter can cause error codes to display on the control pad and prevent the spa from heating properly
- **Water quality:** a change in function of the ozone injection system can result in a drop, or complete stop, of ozone draw into the spa water

Keeping a second set of cartridges and rotating out dirty ones for clean ones can help keep your water clean*, reduce chemical consumption and down time due to cartridge cleaning.

SPECIAL NOTE: Several replacement cartridges look similar. Using the wrong cartridge may cause problems. Ask your dealer for the code that identifies your cartridge and record it.

** Clean is defined as the removal of microscopic (to 30 µm level) debris from the water. Ozone aids in the grouping of small debris. Once combined, the debris can be more easily caught by the filtration process.*

Cleaning Filter Cartridges

- 1) Remove large debris by separating cartridge folds and spraying with a stream of water. Your kitchen or laundry sink is useful for this.
- 2) Contaminants that cause the cartridge to become brownish or greyish in colour require soaking overnight in specially formulated cartridge cleaner (available from your dealer).
- 3) Use a large plastic pail and follow the package directions. For safety reasons, you should locate your soaking pail out of reach of children.
- 4) Rinse the cartridge thoroughly to remove all the cleaner.
- 5) Allow cleaned cartridge to dry completely before re-using.
- 6) Spread pleats and run a soft brush through each one individually to complete the cleaning process.



DRAINING YOUR SPA

Knowing When to Drain

Dissolved solids from bather load and ongoing chemical treatment accumulate in your spa water. The early sign of a high level of dissolved solids is unmanageable cloudy water.

When in doubt, remember that the best chemical for your spa is fresh water!

How to Drain Your Spa

- 1) Turn down the set point on your spa and allow adequate time for the water to cool down. Uncover and run high speed pump to speed up cooling.
- 2) Turn power off to your spa.
- 3) Attach the appropriate size hose to the drain connection (see below).
- 4) Route the hose to an appropriate drain location.
- 5) When the drain is opened the spa will gravity drain, even unattended.
- 6) As draining proceeds, move water from contours of seats, into the footwell. Draining will stop due to drain height.
- 7) Remove any remaining water with a shop vac, sponge and pail or simply dilute in your fresh fill.
- 8) Before refilling, clean spa surface as necessary.
- 9) Don't forget to close the drain before refilling.

If you want to speed up the draining process, simply use a submersible sump pump available through most hardware stores.

Magic Drain Connections (Outer Cabinet)

DRAIN INSTRUCTIONS

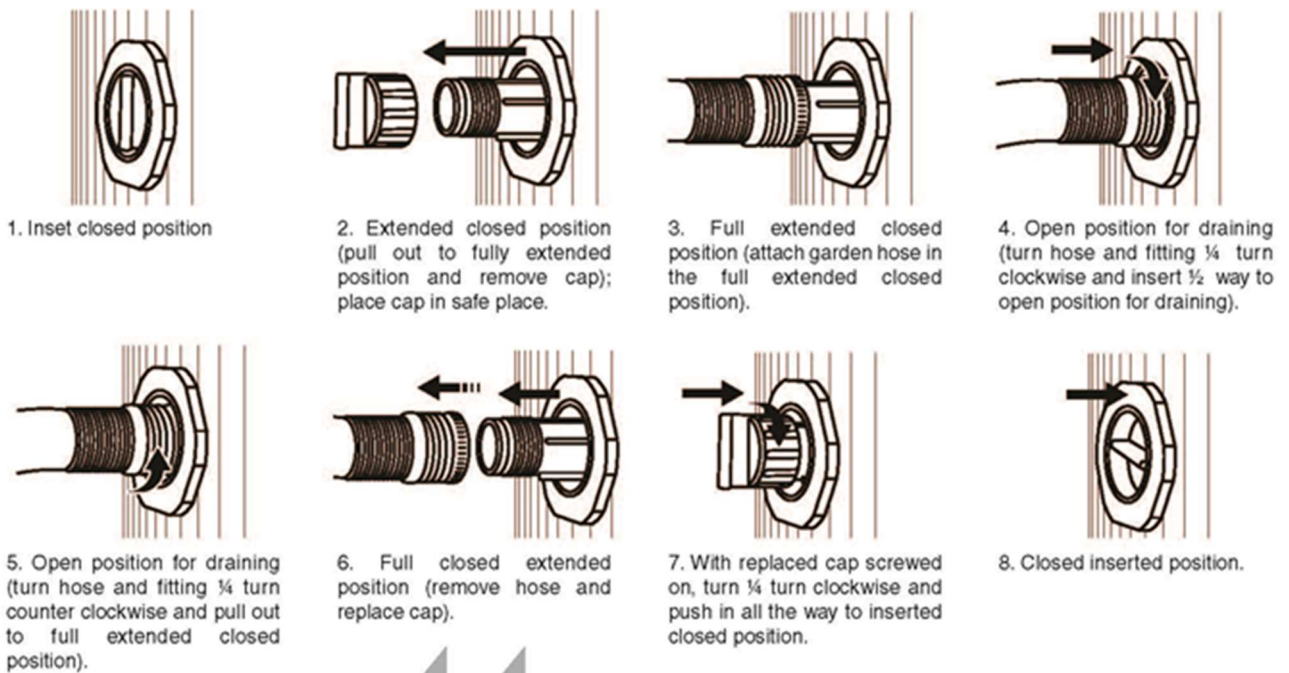

When Vacuuming Spa Lines:

- 1) Vacuum at all suctions in the foot well. This could be 2-6 suctions depending on the model.
- 2) Vacuum at the heater input (union and gate valve), usually on the left of the equipment side of the spa.

Make sure to vacuum until you feel no more water coming out, then block the 2 cartridge mounts or block the Elite or Teleweir opening.

Remove the cartridge(s). Thread plugs into the threaded cartridge mounts in the filter box. For Elite or Teleweir filter system, remove the trim ring and weir. Cover the filter opening with rigid plastic and use something with weight to hold it down and vacuum again at the heater input.

This will help draw water out of any lines connected to the spa pack, especially for spas that do not have a circ pump.

WINTERIZING YOUR SPA

Cold climates, where danger of freezing exists, require special care on your part to prevent damage to the spa shell and equipment. If you plan to use your spa during the cold months, be sure your pump is running frequently enough to keep the water moving so that the heater will operate. It may be best to set your controls to always keep the pump on low speed. This will keep the water from freezing and the heater will come on as the temperatures drop.



WARNING:

If you have a power outage, and cold temperatures are possible, your spa and equipment could freeze, especially if it is mounted in a deck without a cabinet. Ice in the spa and equipment will cause damage. You should consider the need to have your spa professionally winterized if it is to be dormant for a period. This is especially true if you are taking an extended winter vacation.

Follow the procedure below to help prevent damage to your spa and related equipment:

- 1) Drain the spa of all water, as outlined in owner's manual. Shut off the spa's power supply.
- 2) Remove any remaining water with sponge. If you have a shop vac, try vacuuming as much water as possible out of the jets and spa shell. If you cannot remove all the water (especially from the air injectors) RV style or plumbing system anti-freeze should be added to the injectors.
- 3) Remove spa equipment system and pump for storage inside. If this is not practical, use the shop vac again to draw any water from the pump(s) casings. Remove lower casing drain plugs. Add anti-freeze to all pump housings. (See note below)

When vacuuming spa lines:

- a) Vacuum at all suction in the foot well. This could be 2-6 suction depending on the model.
 - b) Vacuum at the heater input (union and gate valve), usually on the left of the equipment side of the spa.
Vacuum until you feel no more water coming out, then block the 2 cartridge mounts or block the Elite or Teleweir opening
Remove the cartridge(s). Thread plugs into the threaded cartridge mounts in the filter box. For Elite or Teleweir filter system, remove the Vane weir/trim ring and float assembly. Cover the filter opening with rigid plastic and use something with weight to hold it down. Vacuum again at the heater input. This will help draw water out of any lines connected to the spa pack, especially for spas that do not have a circ pump.
- 4) The filter should be drained, and cartridge removed and cleaned. Remove the filter cartridge and pour anti-freeze as mentioned earlier into the filter canister. Store the filter element in a room with above freezing temperatures.
 - 5) Support the hard cover along the hinge with 2 by 4's across the spa. Lock your hard cover over the spa and cover entire spa with a tarpaulin. Block the tarp in place or staple to your cabinetry.
 - 6) When you refill in the spring, remember to re-install any plugs that were removed. Follow the directions for start-up, as if this were a new spa.

Note: Any RV style or plumbing system anti-freeze used may leave behind a residue that could cause a white "fizz" in the first refill of water, especially when the jet pump(s) are turned on. You may need to drain and refill the spa to clear away the residue. **During colder months of the year, plumbing anti-freeze is added to all pump housings as part of our production procedures.** This fact is noted on the outer spa packaging.

TROUBLESHOOTING YOUR SPA

Common Problems and How to Solve Them



NOTICE:

Many problems on start-up can be attributed to mis-wiring and a poor understanding of how the spa operates and its' features. Take the time to read and understand this manual. If you have any questions, contact your dealer.

Ground Fault Circuit Interrupter (GFCI) or Residual Current Detector (RCD) Shuts Off on Initial Start-Up

Probable cause:	Mis-wiring of GFCI/RCD.
Action:	Contact electrician and/or dealer.

Ground Fault Circuit Interrupter (GFCI) or Residual Current Detector (RCD) Shuts Off (Not on Initial Start-Up)

Probable cause:	One or more pieces of equipment is shorting to ground or total current draw exceeds GFCI/RCD rating.
Action:	Contact dealer: DO NOT use spa. Take measures to ensure others do not use spa.

Spa is Completely “Dead” (No Circulation and No Display on Topside Control Panel)

Probable cause #1:	GFCI/RCD has tripped (shut off).
Action:	Reset GFCI/RCD and monitor for futures trips. Alert dealer if problem persists.

Probable cause #2:	Breaker or fuse before GFCI/RCD is tripped or blown.
Action:	Shut off GFCI/RCD, reset breaker or replace fuse, reset GFCI/RCD and test. Contact electrician or dealer if problem persists.

Probable cause #3:	Transformer fuse blown in spa pack.
Action:	Locate fuse in spa pack, test and/or replace. Or contact dealer for service.

Probable cause #4:	Insufficient line voltage to power up spa pack processor.
Action:	Contact electrician to measure line voltages and inspect supply connections.

No Heat or Heat Too Low

Probable cause #1:	Set point is not at desired level.
Action:	Review set point and change if necessary.

Probable cause #2:	Circ pump is not running or pumping.
Action:	Check if valves on circ pump/heater system are open (handle pulled up exposing valve shaft, safety clips should be in place to prevent valve closure). Check if circ pump is plugged in or if circ pump fuse in spa pack is burnt out.

Probable cause #3:	Spa is not covered when not being used.
Action:	Cover spa to retain heat.

Probable cause #4:	Heater is not on due to error message showing on display.
Action:	Check for open gate valves on equipment, correct low water level in spa, and examine condition of filter cartridge(s). Turn spa power off then back on. Monitor for reoccurring error message on display. Contact dealer if problem persists.

Probable cause #5:	System Input current setting is restricting heater operation.
Action:	Consult dealer/electrician on system current setup and if a higher input current is available from the supply. This may mean rewiring the spa with a larger gauge cable and/or breaker.

Probable cause #6:	Lack of insulation in a custom installation.
Action:	Protect underside of spa from prevailing cold winds or snow. Enclose custom installations.

Jet(s) Do Not Come on When Pump Key is pressed

Probable cause #1:	Jet pump is not plugged into spa pack.
Action:	Plug pump in and test.

Probable cause #2:	Jet pump fuse blown in spa pack.
Action:	Locate & test/replace pump fuse in spa pack. Contact dealer if problem persists.

Probable cause #3:	Jet pump is not primed.
Action:	Shut off spa and allow trapped air to escape. Restart spa & check jet pump operation. If problem persists, bleed air at pump directly by opening union on pump until all entrapped air is released. Retest.

Probable cause #4:	Individually adjustable volume jets are adjusted to low volume.
Action:	Turn face of specific jet to increase water volume.

Probable cause #5:	Air control is closed. No visible air/water mix.
Action:	Open air control to increase air/water mix.

Probable cause #6:	Pump has overheated and tripped internal thermal overload.
Action:	Wait for pump to cool & listen for "snap" sound as overload resets. Pump should restart. Contact dealer if problem persists.

Probable cause #7:	Pump is not pumping due to broken part inside (motor works, pump is primed but there is no water movement from pump).
Action:	Contact dealer for service.

LED Light(s) Do Not Come on When Light Key is Pressed

Probable cause #1:	Light fuse blown in spa pack
Action:	Locate and test/replace light fuse in spa pack Call dealer if problem persists.

Probable cause #2:	In -line or on-board fuse blown in LED controller
Action:	Locate and test/replace light fuse in LED control box.

No Air/Water Mixture Coming from a Jet

Probable cause #1:	Air control is closed
Action:	Open air control

Probable cause #2:	Water volume through jet is too low to draw air
Action:	Increase water volume by turning jet face

Probable cause #3:	Adjustable jet internal is loose.
Action:	Tighten jet internal

Probable cause #4:	Jet internal is broken or damaged
Action:	Replace jet internal with another one from the spa or with a new one.

Probable cause #5:	Debris inside the jet internal
Action:	Remove the internal, inspect for debris, remove debris and re-install. Test

How to Check a Fuse

Note: You should only remove/check a fuse if you feel comfortable doing so. **Do not risk personal injury. If in doubt, contact your service technician.**

Fuses are located within the wiring compartment. Always replace fuses with the same style and amp value as shown on the label inside the wiring compartment!

Small Glass Fuses

- 1) Shut off power to the spa.
- 2) Use a small screwdriver or pliers to gently remove the fuse from its fuse holder.
- 3) View the filament inside the fuse and replace if broken.
- 4) Use an ohmmeter to check the fuse. Ohms reading should be towards 0 ohms. A reading of infinity means the fuse is open and must be replaced.

Cartridge Fuses & Small Cartridge Fuses

- 1) Shut off power to the spa.
- 2) Use pliers to remove the fuse from its fuse holder.
- 3) Replace fuse and test system.

These types of fuses are available from your local dealer and may be available from local electronic stores and home centres. Each fuse has a voltage and amp rating listed on it and should be used to obtain a replacement fuse.

Note: A single fuse may protect more than 1 component in your spa.

Warranty Service

In the event that you require warranty service, please call the authorized dealer where you purchased the spa. Your dealer has trained service personnel and an obligation to provide you with excellent after-sales service. We conduct yearly training classes to update and refresh technicians.

Confirming a Service Appointment

Have ready the serial number and model number/name of your spa, your date of purchase and store receipt. The spa model and serial number information can be found on the silver and black data plate attached to the lower right corner on the equipment side of the spa. It is also located on the Spa Identification Sheet that is within a plastic bag stapled to the backside of the equipment panel.

WATER TREATMENT GUIDE



HEALTH HAZARD:

The water in your spa must be chemically treated and maintained at regular intervals.

Bacteria can enter your spa water through the fill source, the bathers, and the environment. It is the responsibility of the spa owner to chemically treat the spa water in accordance with the local standards. Cross contamination between bathers can occur.

Your dealer or local pool and spa professional can provide expert testing along with all the products you will need for clear, clean*, healthy spa water. Follow their instructions. Untreated water is not only uncomfortable to relax in; it poses a health hazard to all bathers and a safety hazard to the equipment. Equipment and surface damage caused by poor water treatment and/or unbalanced spa water is not covered under warranty.

MANAGING YOUR SPA WATER



WARNING:

Under Health Canada Re-evaluation Decision RVD-2018-36 **Sodium Bromide Spa Products** are not to be used in combination with:

- An electrolysis device (for example, a chlorine generator)
- Ozonation
- UV

IMPORTANT: * Your dealer may be promoting a water treatment system that does not employ part of all of the general water care instructions below. This guide is designed to give the spa owner a basic understanding of spa water treatment. * When in doubt, follow the recommendations of your dealer. It is recommended that you have your source water tested by your dealer or local testing agency before the first fill. Knowing the characteristics of your source water can help you maintain clean* and clear spa water on a regular basis.

Do not allow any floating chemical dispenser to get drawn in and held in the skimming area. Large amounts of chemicals can become concentrated in one area and damage the acrylic surface. This type of damage is not covered under the warranty.

** Clean is defined as the removal of microscopic (to 30 µm level) debris from the water. Ozone aids in the grouping of small debris. Once combined, the debris can be more easily caught by the filtration process.*

Initial Start-Up

(Review chemical manual - if applicable)

Your spa has _____ litres, _____ gallons of water (please fill in).

- 1) When the spa is full, add a scale preventative to inhibit staining and scale formation.
- 2) Test and adjust alkalinity to level recommended by manufacturer, this stabilizes pH.
- 3) Circulate water for 24 hours.
- 4) Test the pH. The ideal range is 7.2 to 7.6. Adjust, if necessary, with pH Booster or pH Reducer.

- 5) Circulate the water for 30 minutes.
- 6) If you are using Organic Bromine (Bromine Tablets), adjust your dispenser so the bromine residual is 3 to 5 ppm. Lower bromine level may be possible with ozonator.
- 7) Whenever adjusting spa chemicals, less is better. Add chemicals in small amounts over several days.

Does your spa have a Fresh Water Ozone system on it?

- 1) The Fresh Water Ozone System is very simple to monitor. Follow the procedures listed below to ensure continued clean* water.
- 2) Using chlorine and a DPD (diethyl-p-phenylenediamine) test kit, measure Free Available Chlorine (FAC) and Total Chlorine (TC). If the difference is less than 0.5 ppm, the oxidizer from the Fresh Water Ozone system is entering your spa and cleaning your water.
- 3) Check your pH, total alkalinity and calcium hardness as recommended by your Sunrise Spa dealer and adjust if required. Please note: With the Sunrise Fresh Water Ozone system, maintain a pH between 7.6 and 7.8.
- 4) Check the bubble mist entering the spa, via the dedicated ozone/return jet, for consistency. An irregular bubble mist could indicate a blockage in the pump or pipes, a dirty cartridge(s), low water level or pump operation problems.
- 5) On an ultraviolet ozonator, check the glow fitting on the ozonator for a blue colour to ensure that the bulb is on. On a CD ozonator check that the 'power on' indicator light is on.
- 6) Disconnect the tubing from the glow fitting and place your finger over the end of the tubing to feel for suction. This will ensure that the bubble mist entering your spa is coming through the Sunrise Fresh Water Ozone system.

REMEMBER: Your spa water cannot be treated if the circulation system is not operating. The longer the spa's circulation system runs, the cleaner* your water will be. This is not a problem on spa with a dedicated circulation pump. However, on models that use the low speed of a 2-speed pump to circulate the water, the filter cycle should be no less than 4 to 6 hours per day.

* Clean is defined as the removal of microscopic (to 30 µm level) debris from the water. Ozone aids in the grouping of small debris. Once combined, the debris can be more easily caught by the filtration process.



Daily Maintenance

To keep your spa water sparkling clear and odour free, follow these steps:

- 1) Spas with adjustable filter cycles should be operated a minimum of 8 hours a day to remove suspended particles that may exist. (4 hours per a 12-hour period)
- 2) Test pH to maintain a level of 7.2 to 7.6. If an ozonator is being used, pH should be 7.8 while ozonator is working.
- 3) If you are using Organic Bromine (Bromine Tablets) adjust your feeder so the bromine residual is 3 to 5 ppm.

Weekly Maintenance

When the spa is not in use:

- 1) Add 1 cap (30 mL) of a Scale Preventative per 250 gal (1000 Litres) to inhibit scaling and staining. Circulate water for 30 minutes.
- 2) Add a Brightener 24 hours after adding the Scale Preventative. Circulate the water for 30 minutes.
- 3) With the bromine sanitizing system, dirt and grit may build up during the week. The spa should be shocked to eliminate any odour and restore clarity to the water.

Periodic Maintenance

- 1) Greases, oils and organic waste can accumulate on the filter cartridge reducing their efficiency and limiting the effectiveness. Clean the filter with CARTRIDGE CLEANER as directed by the manufacturer. Physically clean the filter basket daily (if applicable).

NOTE: It is not recommended to use muriatic acid on filter cartridges as this is a raw chemical which does not rinse out well, ending up back in the water causing low pH levels.

- 2) The use of the scum reduction product will cut down on grease, foam and suspended particles in the spa. The scum reducer acts as a filter before the filter and will increase the life of the cartridge.
- 3) The use of a thermal insulated hard cover will reduce evaporation and heat loss. Always keep cover on and level when spa is not in use.
- 4) Once you have established a comfortable water temperature to soak at, leave the thermostat at that temperature. Rapid changes in water temperature consume more energy.
- 5) Take a sample of water to your dealer to test for alkalinity, calcium, and total dissolved solids.
- 6) WHEN TO DRAIN SPA WATER. Due to the warm water temperature and high evaporation rate, the total dissolved solids tend to build up. For this reason, we recommend draining and refilling the spa every 2 to 4 months - depending on usage.
- 7) Clean your filter(s) at least once every two weeks or after heavy bather loads, by soaking your filter(s) in cartridge cleaner. Dirty filters cause the heater to shut off or the spa temperature to drift lower than desired.

NOTE: Remove any objects floating on the water before removing skimmer basket and filter or they may be sucked into the pump.

NOTE: Spas should not be left running unattended without filters. Remove filters for cleaning. Always turn off the spa before removing the cartridge(s) Debris can enter plumbing and cause damage.

Chemical Safety Tips

Read the Directions Carefully

- 1) Always add chemicals to water, never add water to chemicals.
- 2) Do not mix chemicals.
- 3) Store chemicals in a cool dry place - out of reach of children.
- 4) In case of contact or if chemical is swallowed, follow emergency advice on product label.
- 5) Do not smoke near chemicals. Keep the container closed when not in use.

Water Balance

Water balance is important to the overall performance of your spa. No 2 spa's water conditions are exactly alike. The water source, location of the spa and frequency of use all effect the water balance. Unbalanced water can damage the equipment, especially the heater element, make the water uncomfortable for the user, and decrease the effectiveness. Total alkalinity, pH, and calcium hardness must be within the correct range to balance the water. Damage to equipment caused by improper water chemistry is not covered by warranty.

pH

Simply pH is a scale indicating whether spa water is basic, neutral or acidic. Spa water should be slightly basic 7.2 to 7.6; 7.8 with an ozonator in operation. A low pH below 7.2 leads to corrosion of spa equipment and will irritate the skin of the bathers. The sanitizer will dissipate more rapidly. A low pH can be corrected by adding a pH Increaser.

Alkalinity

Total alkalinity is a measure of the alkaline level in the water. They act as a pH buffer or a pH stabilizer preventing large changes in the pH. The total alkalinity should be between 80 to 150 ppm: ideally 120 ppm. Tablet bromine tend to gradually lower the alkalinity level.

Low total alkalinity causes:

- the pH to wander
- corrosive water
- sanitizers to be less effective

To raise the total alkalinity, add ALKA RISE™.

High total alkalinity causes:

- cloudy water
- scale formation

To lower the total alkalinity, add a pH Reducer.

Calcium Hardness

Calcium hardness is the hardness present due to dissolved calcium. The desired range is 150 ppm to 280 ppm.

Low calcium hardness causes:

- corrosive water
- staining of spa

To correct this problem, add a Scale Preventative. (Do not fill the spa with soft water!)

PURE WATER SYSTEM



HOW IT WORKS

This system combines the benefits of both Ozone and UV-C creates hydroxyl radicals to burn off contaminants and dissolved solids within the water to significantly increase the clarity of the spa water. The UV-C rays also breakdown chloramines which are the main cause of respiratory, eye and skin irritation typically associated with chlorine. Harmful/corrosive off gassing is also dramatically reduced through this process.

MAINTENANCE AND SERVICE

While operating, check regularly to see if bubbles are entering the spa.

After 10,000 hours the UV LED will begin flashing yellow indicating its time to replace the UV-C lamp.

Replace the check valve assembly annually to ensure continued optimal performance from the Pure Water System.

To replace the UV-C lamp or check valve please go to www.balboawatergroup.com/UVSanitizer for the procedure on how to do this.

IMPORTANT

YOU MUST CONTINUE TO CHECK YOUR WATER CHEMISTRY REGULARLY AND SANITIZING CHEMICALS WILL BE NECESSARY TO TREAT THE WATER. CONSULT YOUR SPA PROFESSIONAL FOR FURTHER ADVICE.

UV-C LAMP REPLACEMENT INSTRUCTIONS

Important: It is mandatory that the UV-C lamp is replaced every 12 months to maintain optimum performance.

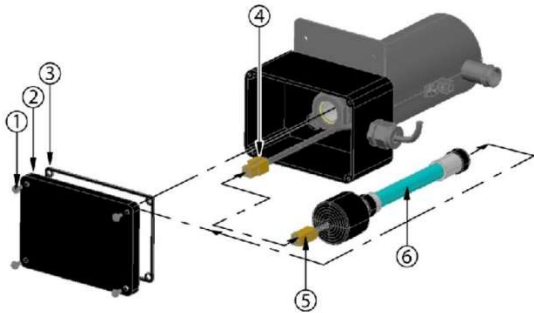

KEY	DESCRIPTION
1	SCREW
2	ENCLOSURE COVER
3	ENCLOSURE GASKET
4	BALLAST CONNECTOR
5	UV-C LAMP CONNECTOR
6	UV-C LAMP

NOTE: Your UV System unit may look different than shown in the picture



DANGER

- Turn the spa breaker to the OFF position.
- Allow the UV-C lamp (6) to cool down prior to removing it from the UV system.
- Never look at the lit UV-C lamp (6). This can cause severe eye damage or blindness.

INSTRUCTIONS:

1. Remove the UV system enclosure cover (2) by removing 4 Phillips screws (1). Keep the gasket (3) together with the enclosure cover (2) for later use.
2. Make sure to use latex glove when handling the UV-C lamp (6).
3. Slowly disconnect the old UV-C lamp connector (5) from the ballast connector (4).
4. Slowly remove the old UV-C lamp (6) from the UV unit.
5. Slide the new UV-C lamp (6) into the UV unit.
6. Reconnect the new UV-C lamp connector (5) to the ballast connector (4). Make sure the connectors mate completely. Do not force.
7. Reinstall the enclosure cover (2) with the gasket (3) and secure with screws (1).
8. Reconnect the unit to the spa controller and reinstall the spa controller's cover.
9. Turn on the power to the spa.
10. Once power is activated you can check the ballast to see if the unit is functioning. A solid green light indicates the unit is being provided power and should always be on. A solid red light indicates that the UV-C lamp is activated.



WARNING

The UV-C lamp used in this unit contains mercury. Properly dispose of the old UV-C lamp in accordance with disposal laws. See www.lamprecycle.org.

Common Spa Water Problems

PROBLEM	POSSIBLE CAUSE	SOLUTION
CLOUDY WATER	<ul style="list-style-type: none"> a) Contaminant build up b) Suspended dirt and grit c) pH high d) Total Alkalinity too high e) Hardness too high f) Poor filtration g) High dissolved solids 	<ul style="list-style-type: none"> a) Shock treatment with a spa shock product b) Add a Brightener, use scum reducer c) Add pH reducer, until pH level reads 7.2 - 7.6 d) Add pH reducer, adjust total alkalinity to 80-150ppm e) Add a Scale Preventative, circulate through a water softener until hardness is 150-280ppm. f) Dirty filter, clean with Cartridge Cleaner g) Empty spa and refill
COLOURED WATER	<ul style="list-style-type: none"> a) Dissolved copper, iron and other metals from source water or equipment b) Algae c) Fragrance 	<ul style="list-style-type: none"> a) Use Scale Preventative, have your dealer check water balance b) Add an Algaecide c) Stop the use of fragrance
FOAMING	<ul style="list-style-type: none"> a) High concentration of oils and dirt/grit being agitated by jets b) Soft water 	<ul style="list-style-type: none"> a) Squirt Defoamer on foam; use the scum reducer or spa ball b) Add a Calcium Increaser until hardness is 150-280ppm.
SCALE DEPOSITS	High calcium level, high pH, high alkalinity	Drain partially, add a Scale Preventative to correct pH level to 7.2 - 7.6 and alkalinity to 80-150ppm.
ODOUR	High level of organics, combined bromine	Shock with a spa shock
EYE/SKIN IRRITATION	pH too low	Add a pH booster until level is 7.2 - 7.6
NO SANITIZER READING	High concentration of dirt and grit using up sanitizers	Add sanitizers until levels are up to recommended range



www.wellnessshop.ca

Version: 05.28.24